

Fast Recovery Epitaxial Diode (FRED)

$I_{FAV} = 60 \text{ A}$
 $V_{RRM} = 600 \text{ V}$
 $t_{rr} = 35 \text{ ms}$

V_{RSM}	V_{RRM}	Type
V	V	
600	600	DSEI 60-06A
600	600	DSEI 60-06AT

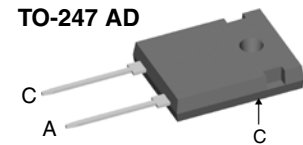
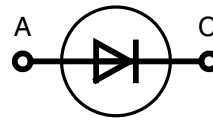

TO-268 AA
(AT Type)

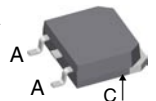

A = Anode, C = Cathode

Symbol	Conditions	Maximum Ratings	
I_{FRMS}		100	A
I_{FAVM} ①	$T_C = 70^\circ\text{C}$; rectangular, $d = 0.5$	60	A
I_{FRM}	$t_p < 10 \mu\text{s}$; rep. rating, pulse width limited by T_{VJM}		
I_{FSM}	$T_{VJ} = 45^\circ\text{C}$; $t = 10 \text{ ms}$ (50 Hz), sine $t = 8.3 \text{ ms}$ (60 Hz), sine	550	A
		600	
	$T_{VJ} = 150^\circ\text{C}$; $t = 10 \text{ ms}$ (50 Hz), sine $t = 8.3 \text{ ms}$ (60 Hz), sine	480	A
		520	
I^2t	$T_{VJ} = 45^\circ\text{C}$; $t = 10 \text{ ms}$ (50 Hz), sine $t = 8.3 \text{ ms}$ (60 Hz), sine	1510	A^2s
		1490	
	$T_{VJ} = 150^\circ\text{C}$; $t = 10 \text{ ms}$ (50 Hz), sine $t = 8.3 \text{ ms}$ (60 Hz), sine	1150	A^2s
		1120	
T_{VJ}		-55...+150	$^\circ\text{C}$
T_{VJM}		150	$^\circ\text{C}$
T_{stg}		-55...+150	$^\circ\text{C}$
P_{tot}	$T_C = 25^\circ\text{C}$	166	W
M_d	mounting torque	0.8...1.2	Nm
Weight	typical	6	g

Features

- International standard package JEDEC TO-247 AD
- Planar passivated chips
- Very short recovery time
- Extremely low switching losses
- Low IRM-values
- Soft recovery behaviour
- Epoxy meets UL 94V-0

Applications

- Antiparallel diode for high frequency switching devices
- Anti saturation diode
- Snubber diode
- Free wheeling diode in converters and motor control circuits
- Rectifiers in switch mode power supplies (SMPS)
- Inductive heating and melting
- Uninterruptible power supplies (UPS)
- Ultrasonic cleaners and welders

Advantages

- High reliability circuit operation
- Low voltage peaks for reduced protection circuits
- Low noise switching
- Low losses
- Operating at lower temperature or space saving by reduced cooling

Symbol	Conditions	Characteristic Values		
		typ.	max.	
I_R	$V_R = V_{RRM}$		200	μA
	$V_R = 0.8 \cdot V_{RRM}$	$T_{VJ} = 25^\circ\text{C}$	100	μA
	$V_R = 0.8 \cdot V_{RRM}$	$T_{VJ} = 125^\circ\text{C}$	14	mA
V_F	$I_F = 70 \text{ A}$	$T_{VJ} = 150^\circ\text{C}$	1.5	V
		$T_{VJ} = 25^\circ\text{C}$	1.8	V
V_{T0}	For power-loss calculations only		1.13	V
r_T	$T_{VJ} = T_{VJM}$		4.7	$\text{m}\Omega$
R_{thJC}	(version A)		0.75	K/W
R_{thCH}		0.25	K/W	
t_{rr}	$I_F = 1 \text{ A}$; $-di_F/dt = 200 \text{ A}/\mu\text{s}$; $V_R = 30 \text{ V}$; $T_{VJ} = 25^\circ\text{C}$	35	50	ns
I_{RM}	$V_R = 350 \text{ V}$; $I_F = 60 \text{ A}$; $-di_F/dt = 480 \text{ A}/\mu\text{s}$ $L \leq 0.05 \mu\text{H}$; $T_{VJ} = 100^\circ\text{C}$	6.0	7.5	A

① I_{FAVM} rating includes reverse blocking losses at T_{VJM} . $V_R = 0.8 \cdot V_{RRM}$, duty cycle $d = 0.5$

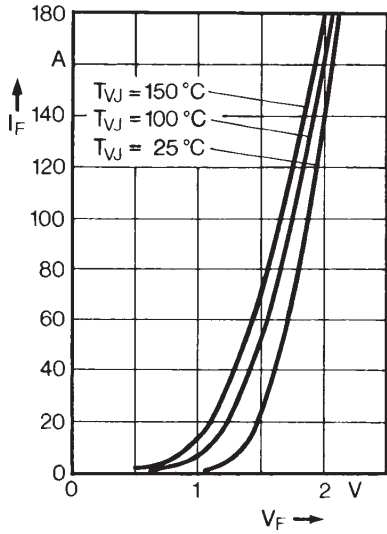

Fig. 1 Forward current versus voltage drop.

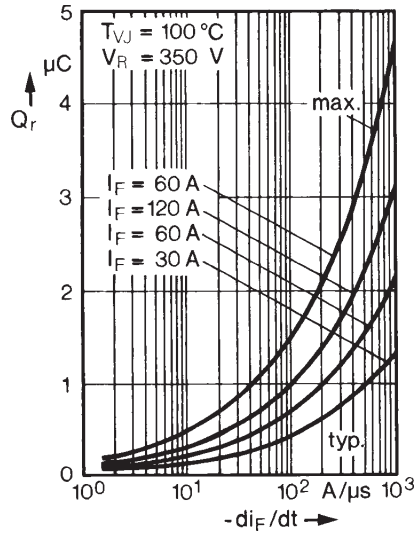

Fig. 2 Recovery charge versus $-di_F/dt$.

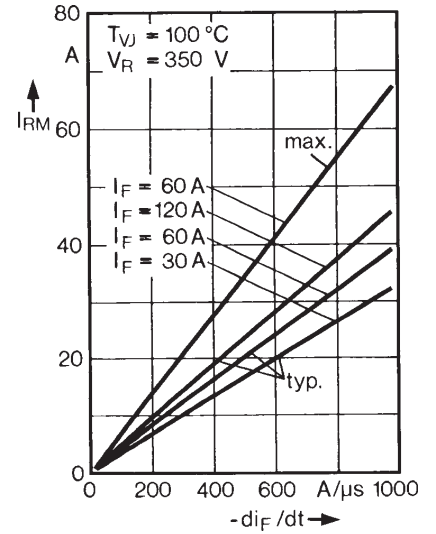

Fig. 3 Peak reverse current versus $-di_F/dt$.

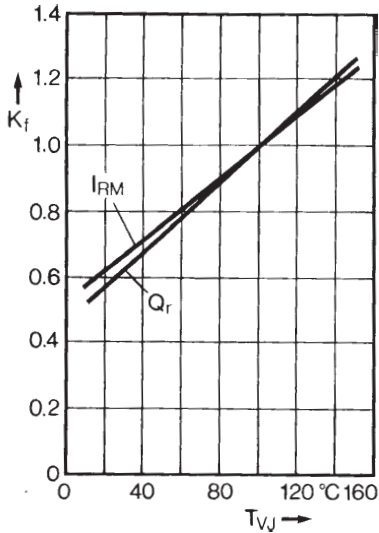

Fig. 4 Dynamic parameters versus junction temperature.

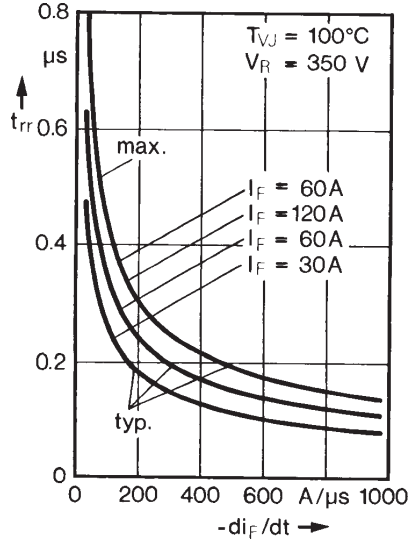

Fig. 5 Recovery time versus $-di_F/dt$.

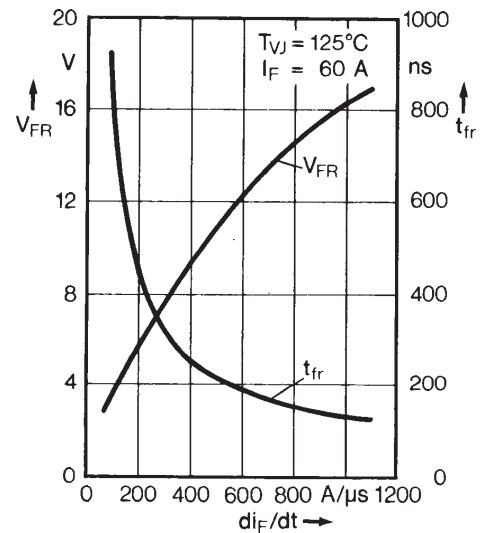

Fig. 6 Peak forward voltage versus di_F/dt .

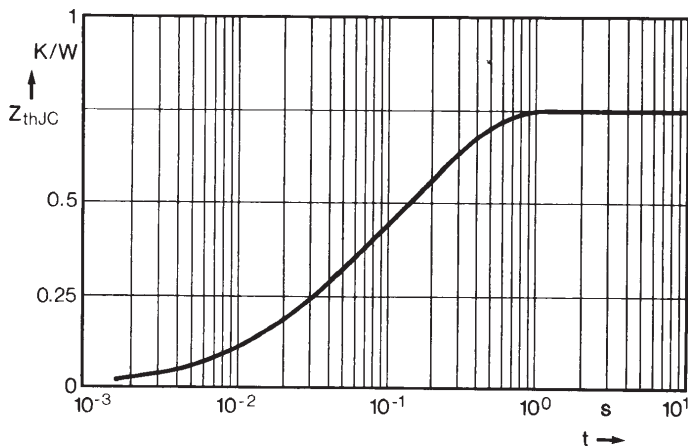
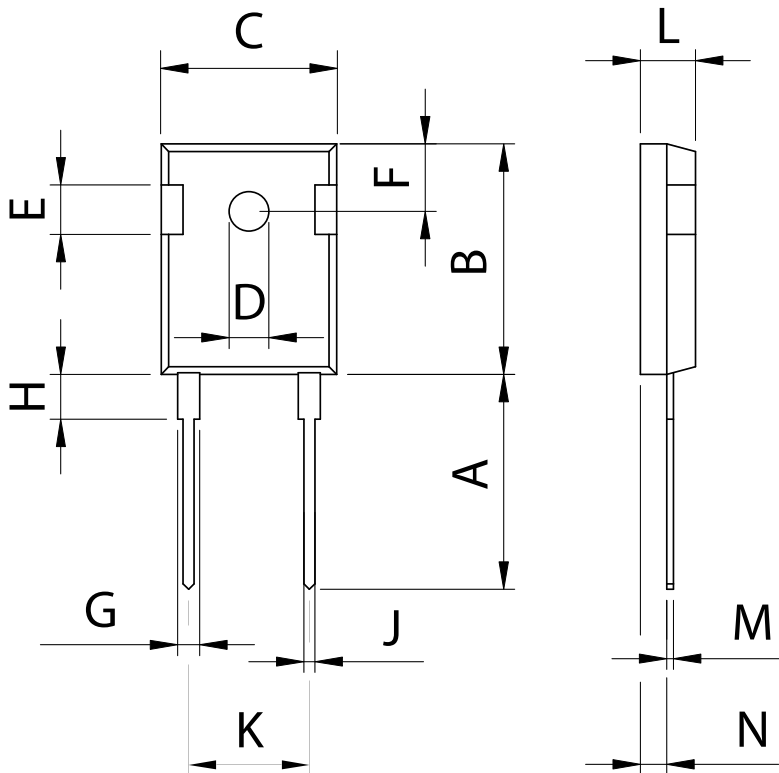

Fig. 7 Transient thermal impedance junction to case.

Dimensions TO-247 AD



Dim.	Millimeter		Inches	
	Min.	Max.	Min.	Max.
A	19.81	20.32	0.780	0.800
B	20.80	21.46	0.819	0.845
C	15.75	16.26	0.610	0.640
D	3.55	3.65	0.140	0.144
E	4.32	5.49	0.170	0.216
F	5.4	6.2	0.212	0.244
G	1.65	2.13	0.065	0.084
H	-	4.5	-	0.177
J	1.0	1.4	0.040	0.055
K	10.8	11.0	0.426	0.433
L	4.7	5.3	0.185	0.209
M	0.4	0.8	0.016	0.031
N	1.5	2.49	0.087	0.102

Dimensions TO-268 AA

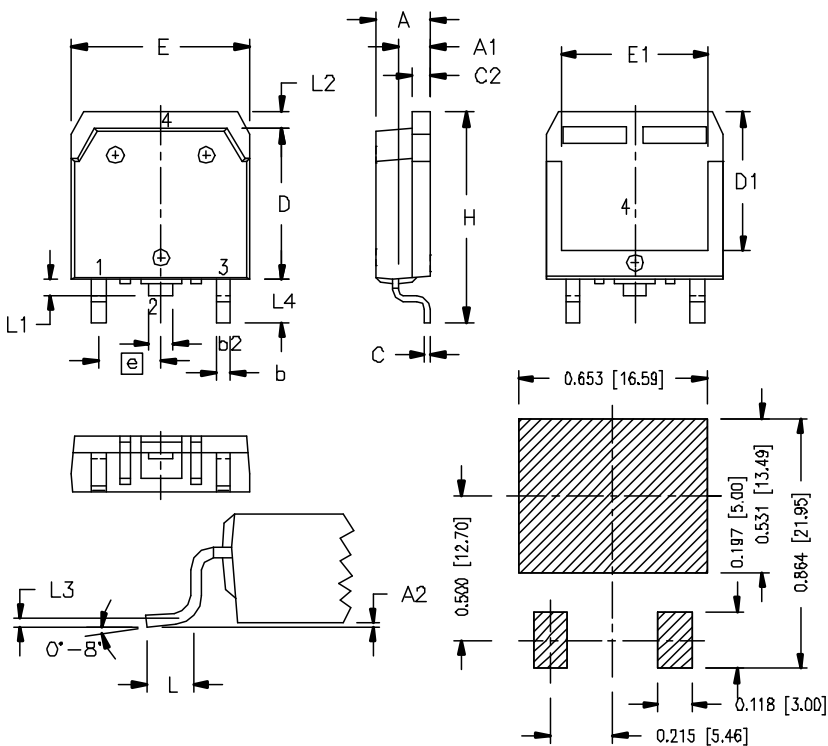

SYM	INCHES		MILLIMETERS	
	MIN	MAX	MIN	MAX
A	.193	.201	4.90	5.10
A1	.106	.114	2.70	2.90
A2	.001	.010	0.02	0.25
b	.045	.057	1.15	1.45
b2	.075	.083	1.90	2.10
C	.016	.026	0.40	0.65
C2	.057	.063	1.45	1.60
D	.543	.551	13.80	14.00
D1	.488	.500	12.40	12.70
E	.624	.632	15.85	16.05
E1	.524	.535	13.30	13.60
e	.215 BSC		5.45 BSC	
H	.736	.752	18.70	19.10
L	.094	.106	2.40	2.70
L1	.047	.055	1.20	1.40
L2	.039	.045	1.00	1.15
L3	.010 BSC		0.25 BSC	
L4	.150	.161	3.80	4.10

RECOMMENDED MINIMUM FOOT PRINT FOR SMD

IXYS reserves the right to change limits, test conditions and dimensions.

© 2007 IXYS All rights reserved

20070419

Mouser Electronics

Authorized Distributor

Click to View Pricing, Inventory, Delivery & Lifecycle Information:

[IXYS:](#)

[DSEI60-06A](#)